

# E7758TR/E7758TP

## TERMINALI + CONNETTORI

### Terminale

Materiale: Ottone stagnato

Per fili da AWG 18 - 22

Utilizzabili nella serie:

EH7758

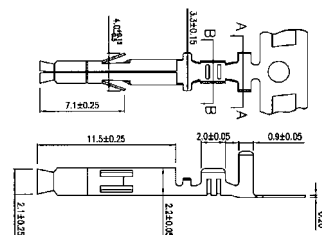
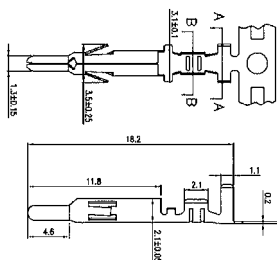

MASCHIO  
E7758TR

FEMMINA  
E7758TP

CODICE	SEZ. FILO	MATERIALE	SPESS.	FINITURA	A	B	C	D	DIAM. ISOLANTE	Q.TÀ PER BOBINA
E7758TR	AWG 18 - 22	Ottone	0,20	Stagnato	4,40	4,20	2,90	2,60	3,40	7.000pz
E7758TP	AWG 18 - 22	Ottone	0,20	Stagnato	4,80	4,10	2,70	2,60	3,40	7.000pz

# EH7758

## TERMINALI + CONNETTORI

### Connettore passo 1.30mm

Materiale: Nylon UL 94V-0

Colore standard: Bianco

Polarizzazione e blocco integrati

Utilizza terminali E7758TR / TP

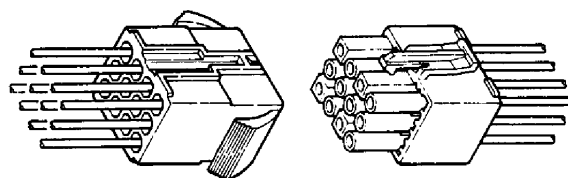

N° di Vie	DIMENSIONI	
2	<p><b>EH7758PI-02 (Senza Alette)</b> <b>EH7758P-02 (Con Alette)</b></p>	<p><b>EH7758RI-02</b></p>
3	<p><b>EH7758PI-03 (Senza Alette)</b> <b>EH7758P-03 (Con Alette)</b></p>	<p><b>EH7758RI-03</b></p>

# EH7758

## TERMINALI + CONNETTORI

Connettore passo 1.30 mm

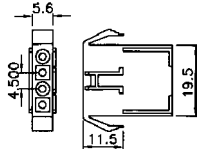
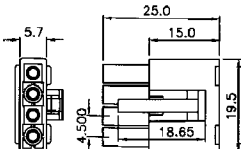
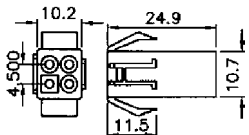
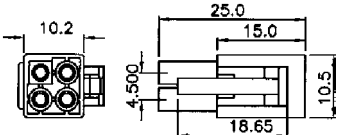
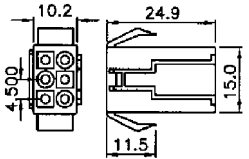
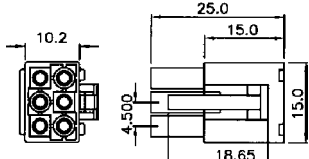
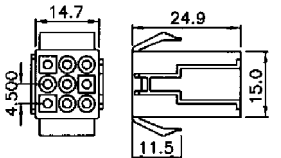
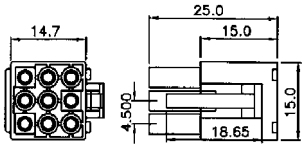
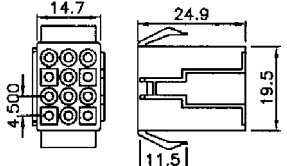
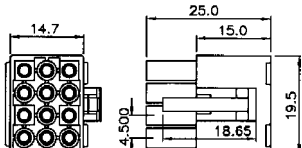
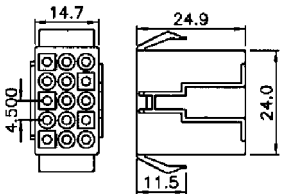
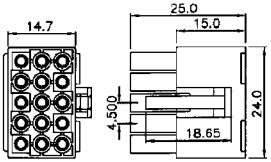
N° di Vie	DIMENSIONI	
4	 <p><b>EH7758PI-04 (Senza Alette)</b> <b>EH7758P-04 (Con Alette)</b></p>	 <p><b>EH7758RI-04</b></p>
2x2	 <p><b>EH7758PI-2x2 (Senza Alette)</b> <b>EH7758P-2x2 (Con Alette)</b></p>	 <p><b>EH7758RI-2x2</b></p>
6	 <p><b>EH7758PI-06 (Senza Alette)</b> <b>EH7758P-06 (Con Alette)</b></p>	 <p><b>EH7758RI-06</b></p>
9	 <p><b>EH7758PI-09 (Senza Alette)</b> <b>EH7758P-09 (Con Alette)</b></p>	 <p><b>EH7758RI-09</b></p>
12	 <p><b>EH7758PI-12 (Senza Alette)</b> <b>EH7758P-12 (Con Alette)</b></p>	 <p><b>EH7758RI-12</b></p>
15	 <p><b>EH7758PI-15 (Senza Alette)</b> <b>EH7758P-15 (Con Alette)</b></p>	 <p><b>EH7758RI-15</b></p>

# EI0272BS-2/EI1272BS-2

## TERMINALI + CONNETTORI

### Terminali

Materiale: Ottone stagnato  
 Utilizzati nella serie EHL20  
 Accetta filo da AWG # 14 - 18

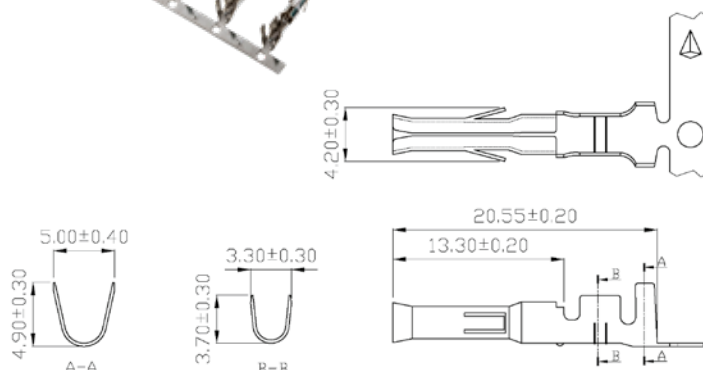
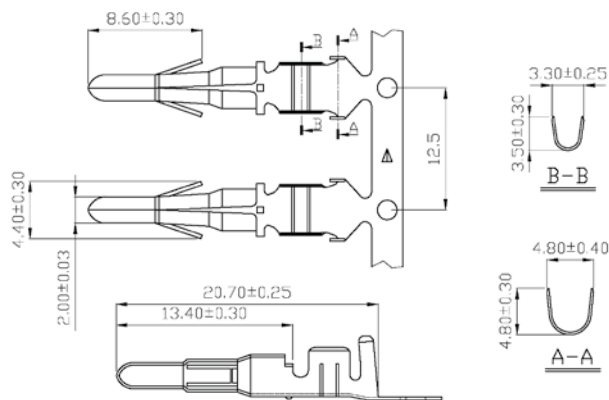

MASCHIO  
EI0272BS-2

FEMMINA  
EI1272BS-2

CODICE	SEZ. FILO	MATERIALE	SPESS.	FINITURA	A	B	C	D	DIAM. ISOLANTE	Q.TÀ PER BOBINA
EI1272BS-2	AWG 14 - 18	Ottone	0,25	Stagnato	5,00	4,90	3,30	3,70	3,60	3.500pz
EI0272BS-2	AWG 14 - 18	Ottone	0,25	Stagnato	4,80	4,80	3,30	3,50	3,60	3.500pz

# EHL20

## TERMINALI + CONNETTORI

### Connettore passo 2.00mm

Materiale: Nylon UL 94V-2  
 Polarizzazione integrata  
 Utilizza i terminali EL20T / EL21T

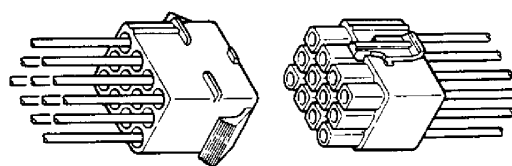

N° di Vie	DIMENSIONI	
1	<p><b>EHL20P-01 (Con Alette)</b>  <b>EHL20PI-01 (Senza Alette)</b></p>	<p><b>EHL20RI-01</b></p>

# EHL20

## TERMINALI + CONNETTORI

Connettore passo 2.00 mm

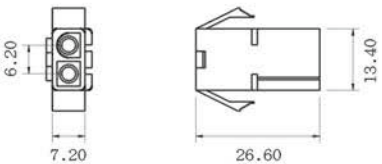
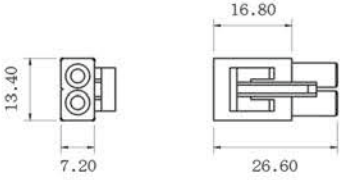
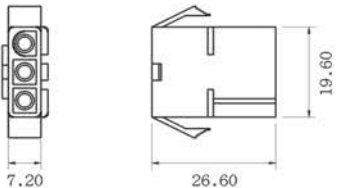
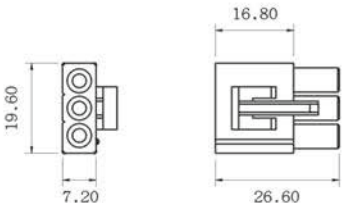
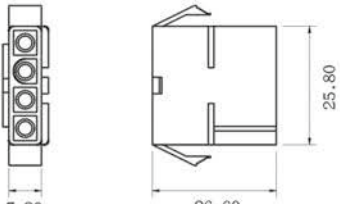
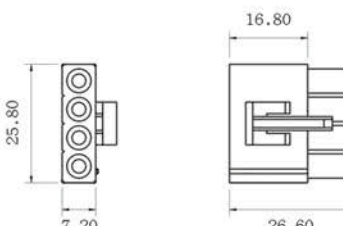
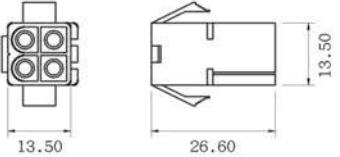
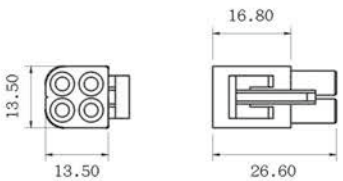
N° di Vie	DIMENSIONI	
2	 <p><b>EHL20P-02 (Con Alette)</b> <b>EHL20PI-02 (Senza Alette)</b></p>	 <p><b>EHL20RI-02</b></p>
3	 <p><b>EHL20P-03 (Con Alette)</b> <b>EHL20PI-03 (Senza Alette)</b></p>	 <p><b>EHL20RI-03</b></p>
4	 <p><b>EHL20P-04 (Con Alette)</b> <b>EHL20PI-04 (Senza Alette)</b></p>	 <p><b>EHL20RI-04</b></p>
2x2	 <p><b>EHL20P-2x2 (Con Alette)</b> <b>EHL20PI-2x2 (Senza Alette)</b></p>	 <p><b>EHL20RI-2x2</b></p>

# EHL20

## TERMINALI + CONNETTORI

Connettore  
passo 2.00mm

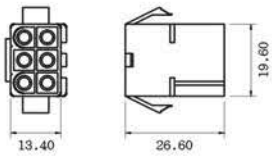
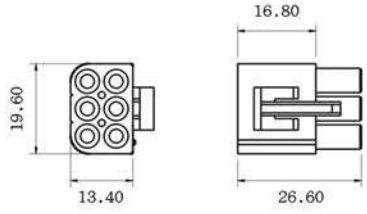
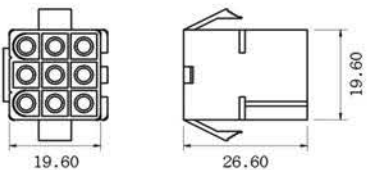
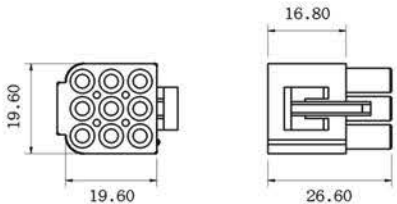
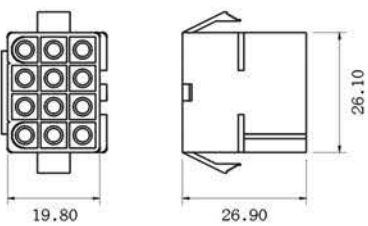
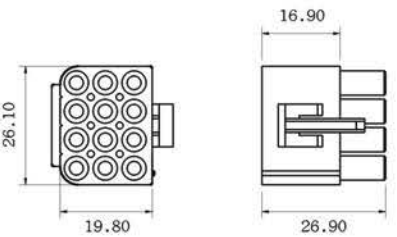
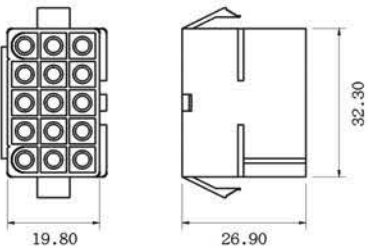
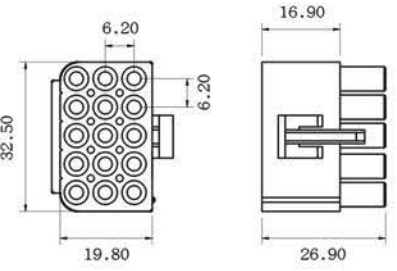
N° di Vie	DIMENSIONI	
6	 <p><b>EHL20P-06 (Con Alette)</b> <b>EHL20PI-06 (Senza Alette)</b></p>	 <p><b>EHL20RI-06</b></p>
9	 <p><b>EHL20P-09 (Con Alette)</b> <b>EHL20PI-09 (Senza Alette)</b></p>	 <p><b>EHL20RI-09</b></p>
12	 <p><b>EHL20P-12 (Con Alette)</b> <b>EHL20PI-12 (Senza Alette)</b></p>	 <p><b>EHL20RI-12</b></p>
15	 <p><b>EHL20P-15 (Con Alette)</b> <b>EHL20PI-15 (Senza Alette)</b></p>	 <p><b>EHL20RI-15</b></p>