

AHI-JS-DR-03-121

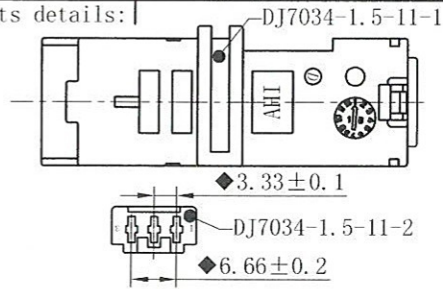

Parts details:



MARK	ECN	DESCRIPTION	DWN.	DATE

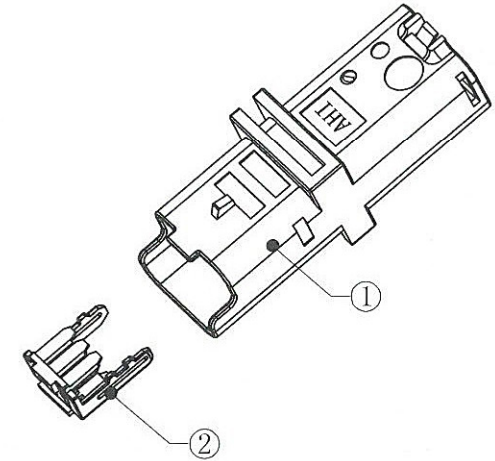
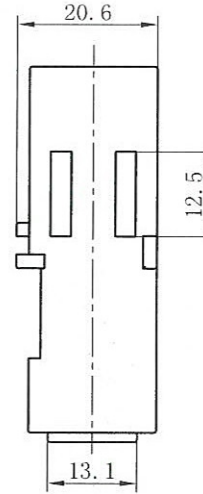
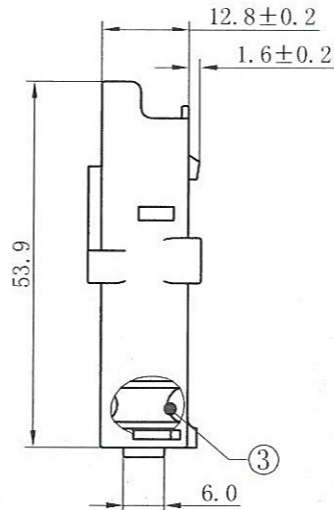
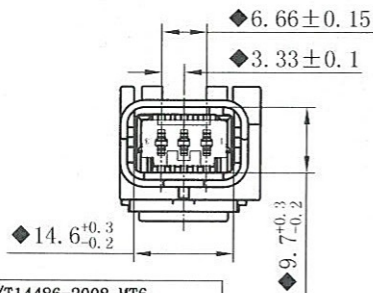
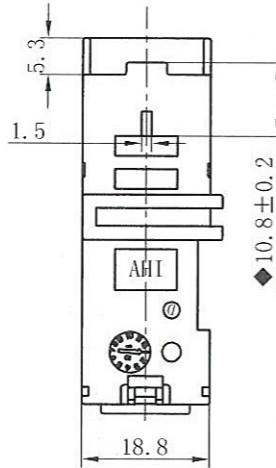
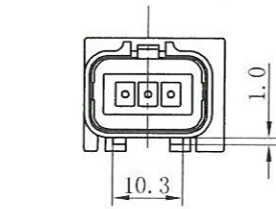

Note: The mating terminal is: DJ617-1.5×0.8

COLOUR	SEE TABLE	AHI				
MATERIAL	SEE TABLE	Wenzhou Aohai Electric Co., Ltd.				
NAME	3HOLE CONNECTOR	DRAWN BY	CONFIRMED BY	APPROVED BY		
PART NO.	EMTQ03MB-AHI	林 2015.7.3	赵 2015.7.4	罗 2015.7.4		
TYPE	DJ7034-1.5-11	REV.	1st-PERSON VIEW	FREE	UNIT	PAGE
ARTICLE NO.		1.0		1.5:1	mm	1/1
MOULD NO.:						

NO. TOLERANCES GB/T14486-2008-MT6			
DIM. RANGE	DIM. TOLERANCES	DIM. RANGE	DIM. TOLERANCES
0~3	±0.23	>18~24	±0.41
>3~6	±0.26	>24~30	±0.45
>6~10	±0.29	>30~40	±0.50
>10~14	±0.33	>40~50	±0.57
>14~18	±0.37	>50~65	±0.65

NO.	PART NO.	NAME	MATERIAL	Q'TY	COLOUR
③	DJ7034-1.5-21-4	WIRE SEAL	SILICONE RUBBER	1	GREEN
②	DJ7034-1.5-11-2	LOCK	PBT	1	YELLOW
①	DJ7034-1.5-11-1	HOUSING	PA66	1	BLACK